

SPECIFICATION (50Hz)

Voltage (V)	230
Watt (W)	32
Amps (A)	0.15
Speed (rpm)	1400
Capacitor (μ F)	1.0
Airflow (m^3/hr)	350
Noise (db)	56
Net Weight (Kg) (With Bucket Grill)	1.6

PERFORMANCE CURVE

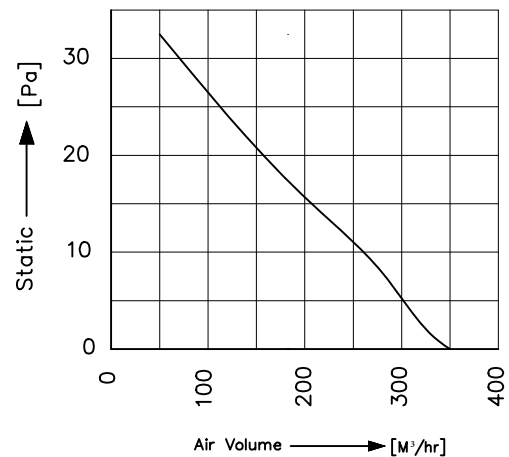

Conversion: 100pa \approx 0.4" H2O 100m³/hr \approx 60cfm

All information contained in this document is CONFIDENTIAL and the property of ROTECH. Reproduction of this any form is to be done with the specific permission of the company.

*Material :

- Blade: Steel, powder coated
- Grill: Steel, powder coated
- Rotor: Powder coated
- Housing: Steel, powder coated

*Type of protection: IP-54

*Insulation Class: "F"- Class

*Bearing: Maintenance free Ball Bearing.

*Permissible ambient temperature: 0 to 60° C

*High Voltage test according to IS: 3588-1987

*Balancing Grade: Fans conform 6.3 Grade as recommended by IS 1940-1-2003

*Direction of rotation: Sucking- Counter clockwise

Blowing- Clockwise, Seen on rotor

*Wiring Diagram :

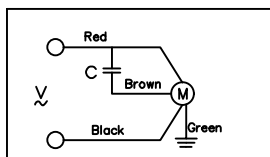

MODEL : AF200-4E-S1

SCALE: NTS | Page 1 of 2

REV/DATE: 04,01.02.2020

PREPARED BY : J.G.P

CHECKED BY : S.B.D

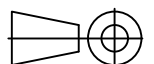

ACCESSORIES

Flat Grill

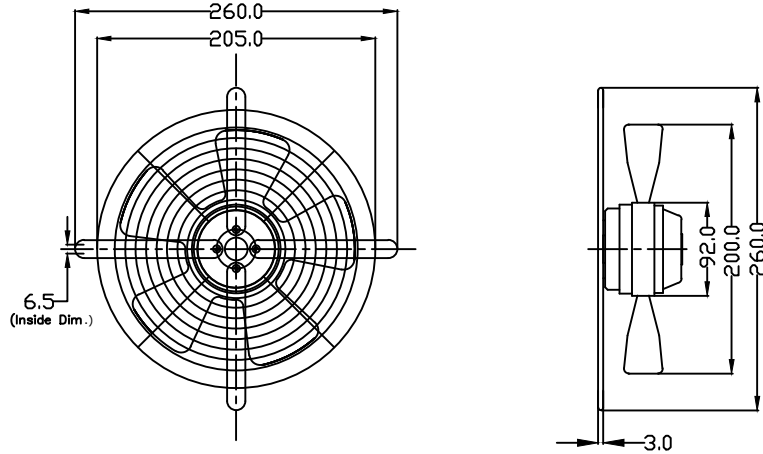

Housing

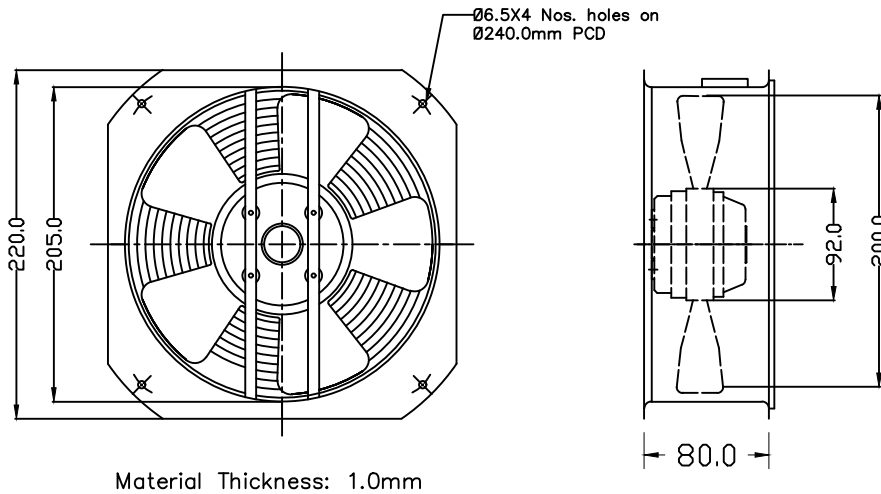

Exhaust Fan Frame

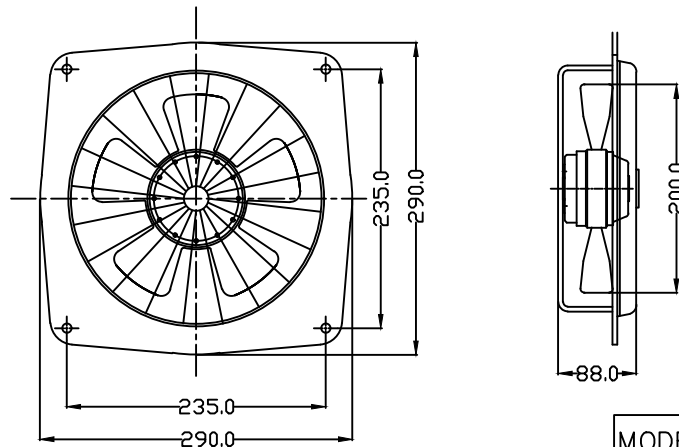

All information contained in this document is CONFIDENTIAL and the property of ROTECH. Reproduction of this any form is to be done with the specific permission of the company.

NOTE: ALL DIMENSIONS ARE IN MM.

MODEL : AF200-4E-S1

SCALE: NTS | Page 2 of 2

REV/DATE: 04,01.02.2020

PREPARED BY : J.G.P

CHECKED BY : S.B.D

